

Measuring Guide for Wood Blinds and Faux Wood Blinds

Tools and Tips

- **Steel tape measure** – do not use cloth tape
- **Pencil**
- **Measurement Worksheet** – attached
- **Measure each window** and identify window locations – size variances are common
- **Round measurements** to the nearest $\frac{1}{8}$ "
- **Clearly record measurements** – width vs. height

Double-check your work—always measure twice to ensure accuracy.

7/8" →
3/4" →
5/8" →
1/2" →
3/8" →
1/4" →
1/8" →

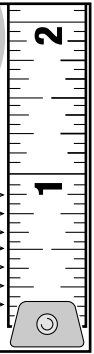

Choose a Mount Type: Inside Mount or Outside Mount

(See page 3 if you need help deciding which mount is best for your windows.)

Inside Mount Window treatments are installed inside the window casing.

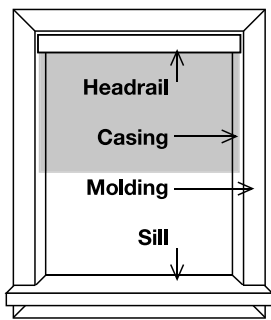

Inside Mount Blind

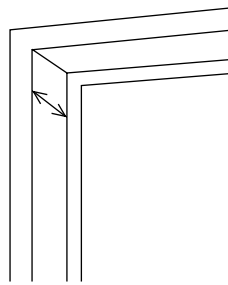

Depth

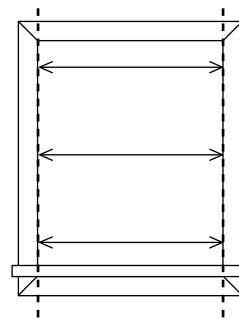

Width

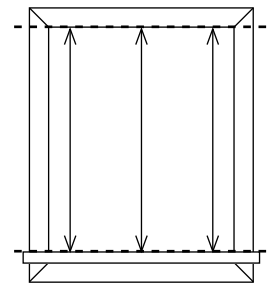

Height

- 1 **Measure Depth:** Measure your depth to see if you have full recess depth. If you do, no returns are necessary. If you do not, please see the special return section of this measuring guide. $\frac{3}{4}$ " is the minimum depth required for inside mount blinds.
- 2 **Measure Width:** Measure the inside width of window casing in three places. Record narrowest measurement.
- 3 **Measure Height:** Measure the inside height from the bottom of the top window casing to the top of sill in three places. Record longest measurement.

Note: Do not take any deductions for clearance. The manufacturer will take necessary deductions for a perfect fit.

Outside Mount Window treatments are installed outside the window casing. Mount directly to wall or molding.

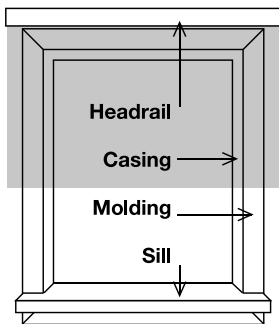

Outside Mount Blind

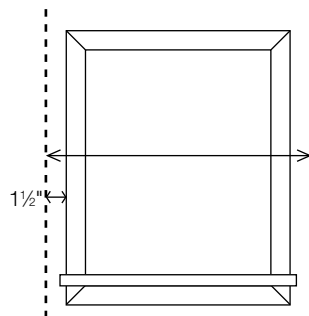

Width

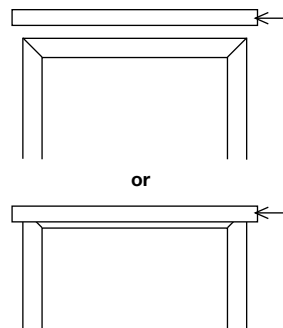

Headrail Location

Proposed Headrail Location

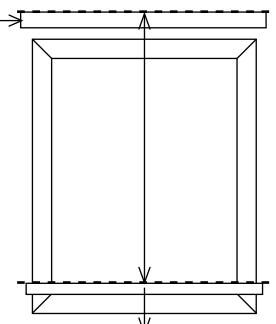

Height

- 1 **Measure Width:** Measure width to be covered. We recommend $1\frac{1}{2}$ " overlap on each side of the window (3" total) for optimum light control and privacy. Record measurement.
- 2 **Determine Headrail Location:** Determine if headrail will be on molding or above molding and mark spot.
- 3 **Measure Height:** Measure height to be covered from top of headrail location to top of sill or lower if overlap is desired for additional light control and privacy. Record measurement.

Note: The manufacturer makes **NO** deductions on **WIDTH** on outside mount installations.

How To Measure Multiple Blinds On One Headrail

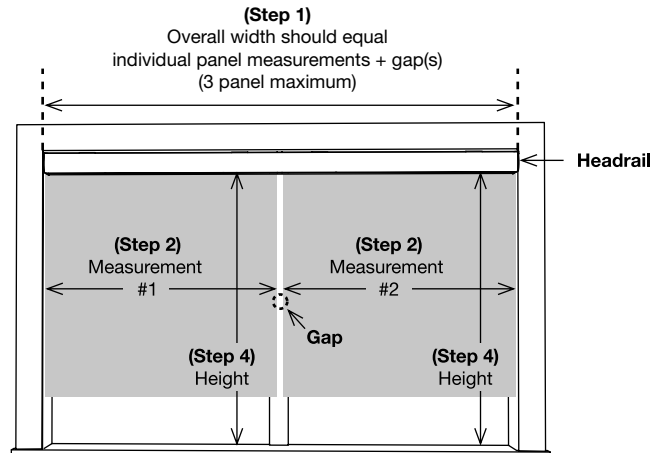

- 1 Measure overall width of the area to be covered. If space permits, an overlap of 1½" (3.9 cm) per side is recommended for outside mounts.
- 2 Measure the width of the area each blind is to cover. Measure and specify the left blind first, continuing to the right. Allow a minimum of ¼" (0.7 cm) between blinds for operating clearance. (½" minimum for NoHoles™)
- 3 Total width of all blinds, plus clearance(s), must equal overall width.
- 4 Measure height as follows:
 - a. For windows, use standard inside or outside measuring procedures.
 - b. For patio doors, measure height within ¾" (2.0 cm) of floor, either from ceiling or a point at least 6½" (16.6 cm) above the door frame.

How to Order Multiple Blinds on One Headrail

- 1 Indicate whether two or three blinds are to be mounted on one headrail.
- 2 Specify total width of headrail.
- 3 Indicate each panel width separately, specify left blind first, continuing to the right.
- 4 Specify control positions.
- 5 Add appropriate surcharge, if to the left of the solid line on the price chart.

Example: Left Panel (49⅞") + Gap (¼") + Right Panel (49⅞") = Overall (100").

Reasons for Choosing Inside Mount

- These treatments are installed inside the window casing, showcasing attractive window trim.
- In some deep-set windows, the window treatment can be installed to allow plants or other items to be placed in front of the window treatment on the sill.

Limitations of Inside Mount

- A small deduction in the width and/or length is taken by the manufacturer to allow for proper operating clearance, and this causes small amount of light to spill through on each side of the treatment.
- The stack (thickness of the window treatment when fully raised) will obstruct part of the view from the window.
- Obstacles such as handles and cranks can interfere with the operation of inside mount treatments.

Reasons for Choosing Outside Mount

- Light spilling through on the side of the window treatment can be substantially diminished or eliminated.
- Ideal for covering windows that are not level.
- Because they are installed higher than the window opening, these treatments offer an unobstructed view when fully raised.
- These treatments can clear obstacles like handles and cranks.
- Increase overlap above and below or to each side of the window to enlarge the look of a small window.
- These treatments can easily hide unattractive window trim.

Limitations of Outside Mount

- Brackets require at least 2" of flat surface above window or on window frame for installation. Projection brackets or shims can be ordered if needed to clear frame or molding.

Special Return Ordering

- Locate your valance profile on the Valance Options chart, and then find the **standard valance return width** for your control type.
- Subtract your window depth from your **standard valance return width**. This calculation is your **special return width**.
- Standard return width for 2 $\frac{1}{2}$ " blinds—subtract $\frac{3}{16}$ " prior to determining **special return width**.
- Standard return width for 2 $\frac{1}{2}$ " blinds—subtract $\frac{3}{8}$ " prior to determining **special return width**.
- Place order **with special return width**.

Valance Options

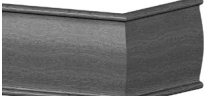

Valance Type	Blind Type	Maximum Continuous Width*		Control Type	Standard Valance Returns inches (cm)	Full Recess Depth inches (cm)
		Inside Mount No Returns inches (cm)	Inside Mount with Returns inches (cm)			
2$\frac{1}{2}$" (6.4 cm) Classic Valance  Valance Returns $\frac{1}{2}$ " (1.3 cm) to 1" (2.6 cm): glued 1 $\frac{1}{16}$ " (2.7 cm) to 4 $\frac{3}{16}$ " (11.8 cm): optional glued 4 $\frac{1}{16}$ " (12.0 cm) and greater: not glued	2" (5.1 cm) Barnwood [^]	100 $\frac{1}{4}$ (254.7)	98 $\frac{3}{8}$ (249.9)	Cord tilt	2 $\frac{7}{8}$ (7.4)	3 $\frac{1}{4}$ (8.3)
				Wand tilt	3 $\frac{3}{16}$ (9.1)	3 $\frac{3}{8}$ (9.9)
				Cordless wand tilt	3 $\frac{3}{8}$ (8.6)	3 $\frac{3}{4}$ (9.6)
				Cordless cord tilt	2 $\frac{3}{4}$ (7.0)	3 $\frac{1}{16}$ (7.8)
3" (7.7 cm) Classic Valance  Valance Returns $\frac{1}{2}$ " (1.3 cm) to 1" (2.6 cm): glued 1 $\frac{1}{16}$ " (2.7 cm) to 4 $\frac{3}{16}$ " (11.8 cm): optional glued 4 $\frac{1}{16}$ " (12.0 cm) and greater: not glued	1" (2.6 cm) Wood	100 $\frac{1}{4}$ (254.7)	98 $\frac{3}{8}$ (249.9)	Wand tilt	2 $\frac{1}{16}$ (5.3)	2 $\frac{3}{8}$ (6.1)
	2" (5.1 cm) Wood 2" (5.1 cm) Elite Wood	100 $\frac{1}{4}$ (254.7)	98 $\frac{3}{8}$ (249.9)	Cord tilt	2 $\frac{7}{8}$ (7.4)	3 $\frac{1}{4}$ (8.3)
				Wand tilt	3 $\frac{3}{8}$ (9.1)	3 $\frac{7}{8}$ (9.9)
	2 $\frac{3}{8}$ " (6.1 cm) Wood 2 $\frac{3}{8}$ " (6.1 cm) Elite Wood	100 $\frac{1}{4}$ (254.7)	98 $\frac{3}{8}$ (249.9)	Cordless wand tilt	3 $\frac{3}{8}$ (8.6)	3 $\frac{3}{4}$ (9.6)
				Cordless cord tilt	2 $\frac{3}{4}$ (7.0)	3 $\frac{1}{16}$ (7.8)
	Wood Verticals	100 $\frac{1}{4}$ (254.7)	98 $\frac{3}{8}$ (249.9)	Cord tilt	3 $\frac{3}{4}$ (9.6)	4 $\frac{1}{8}$ (10.4)
				Wand tilt	3 $\frac{3}{4}$ (9.6)	4 $\frac{1}{16}$ (10.4)
	2" (5.1 cm) Composite [^]	106 $\frac{3}{8}$ (270.9)	105 $\frac{3}{8}$ (267.7)	Cordless wand tilt	3 $\frac{3}{8}$ (9.1)	3 $\frac{1}{2}$ (10.1)
				Cordless cord tilt	3 $\frac{3}{8}$ (9.1)	3 $\frac{1}{16}$ (10.1)
	2 $\frac{1}{2}$ " (6.4 cm) Composite [^]	106 $\frac{3}{8}$ (270.9)	105 $\frac{3}{8}$ (267.7)	N/A	5 $\frac{1}{2}$ (14.0)	5 $\frac{1}{16}$ (14.8)
				Cord tilt	2 $\frac{7}{8}$ (7.4)	3 $\frac{1}{4}$ (8.3)
	2" (5.1 cm) Premium Faux Wood [^] 2" (5.1 cm) Faux Wood [^]	106 $\frac{3}{8}$ (270.9)	105 $\frac{3}{8}$ (267.7)	Wand tilt	3 $\frac{3}{8}$ (9.1)	3 $\frac{7}{8}$ (9.9)
				Cordless wand tilt	3 $\frac{3}{8}$ (8.6)	3 $\frac{3}{4}$ (9.6)
2 $\frac{1}{2}$ " (6.4 cm) Premium Faux Wood [^] 2 $\frac{1}{2}$ " (6.4 cm) Faux Wood [^]	106 $\frac{3}{8}$ (270.9)	105 $\frac{3}{8}$ (267.7)	Cordless cord tilt	2 $\frac{3}{4}$ (7.0)	3 $\frac{1}{16}$ (7.8)	
			Cord tilt	3 $\frac{1}{16}$ (10.1)	4 $\frac{1}{8}$ (10.8)	
2" (5.1 cm) Premium Faux Wood [^] 2" (5.1 cm) Faux Wood [^]	106 $\frac{3}{8}$ (270.9)	105 $\frac{3}{8}$ (267.7)	Wand tilt	3 $\frac{1}{16}$ (10.1)	4 $\frac{1}{8}$ (10.8)	
			Cordless wand tilt	3 $\frac{3}{4}$ (9.6)	4 $\frac{1}{8}$ (10.5)	
2" (5.1 cm) Premium Faux Wood [^] 2" (5.1 cm) Faux Wood [^]	106 $\frac{3}{8}$ (270.9)	105 $\frac{3}{8}$ (267.7)	Cord tilt	2 $\frac{7}{8}$ (7.4)	3 $\frac{1}{4}$ (8.3)	
			Wand tilt	3 $\frac{3}{8}$ (9.1)	3 $\frac{7}{8}$ (9.9)	
2" (5.1 cm) Premium Faux Wood [^] 2" (5.1 cm) Faux Wood [^]	106 $\frac{3}{8}$ (270.9)	105 $\frac{3}{8}$ (267.7)	Cordless wand tilt	3 $\frac{3}{8}$ (8.6)	3 $\frac{3}{4}$ (9.6)	
			Cordless cord tilt	2 $\frac{3}{4}$ (7.0)	3 $\frac{1}{16}$ (7.8)	
2" (5.1 cm) Premium Faux Wood [^] 2" (5.1 cm) Faux Wood [^]	106 $\frac{3}{8}$ (270.9)	105 $\frac{3}{8}$ (267.7)	Cord tilt	3 $\frac{1}{16}$ (10.1)	4 $\frac{1}{8}$ (10.8)	
			Wand tilt	3 $\frac{1}{16}$ (10.1)	4 $\frac{1}{8}$ (10.8)	
2" (5.1 cm) Premium Faux Wood [^] 2" (5.1 cm) Faux Wood [^]	106 $\frac{3}{8}$ (270.9)	105 $\frac{3}{8}$ (267.7)	Cordless wand tilt	3 $\frac{3}{4}$ (9.6)	4 $\frac{1}{8}$ (10.5)	
			Cordless cord tilt	3 $\frac{3}{4}$ (9.6)	4 $\frac{1}{8}$ (10.5)	

*Continuous valances wider than sizes shown above will have two or more sections spliced together with a keystone.

Maximum width for spliced valances is 300 $\frac{3}{4}$ " (764.0 cm).

[^]Keystones not available.

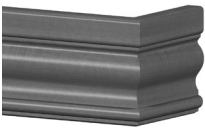
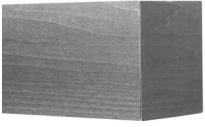
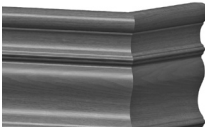
Valance Options

Valance Type	Blind Type	Maximum Continuous Width*		Control Type	Standard Valance Returns inches (cm)	Full Recess Depth inches (cm)
		Inside Mount No Returns inches (cm)	Inside Mount with Returns inches (cm)			
3" (7.7 cm) Majestic Valance  Valance Returns ½" (1.3 cm) to 1" (2.6 cm): glued 1⅛" (2.7 cm) to 4⅝" (11.8 cm): optional glued 4⅞" (12.0 cm) and greater: not glued	2" (5.1 cm) Composite [^]	106⅞" (270.9)	105⅞" (267.7)	Cord tilt Wand tilt Cordless wand tilt Cordless cord tilt	2⅞" (7.4) 3⅞" (9.1) 3⅞" (8.6) 2¾" (7.0)	3⅞" (8.6) 4⅞" (10.4) 3⅞" (9.9) 3⅞" (8.1)
	2½" (6.4 cm) Composite [^]	106⅞" (270.9)	105⅞" (267.7)	Cord tilt Wand tilt Cordless wand tilt Cordless cord tilt	3⅞" (10.1) 3⅞" (10.1) 3⅞" (9.6) 3⅞" (9.6)	4⅞" (11.3) 4⅞" (11.3) 4⅞" (10.8) 4⅞" (10.8)
	2" (5.1 cm) Premium Faux Wood [^] 2" (5.1 cm) Faux Wood [^]	106⅞" (270.9)	105⅞" (267.7)	Cord tilt Wand tilt Cordless wand tilt Cordless cord tilt	2⅞" (7.4) 3⅞" (9.1) 3⅞" (8.6) 2¾" (7.0)	3⅞" (8.6) 4⅞" (10.4) 3⅞" (9.9) 3⅞" (8.1)
	2½" (6.4 cm) Premium Faux Wood [^] 2½" (6.4 cm) Faux Wood [^]	106⅞" (270.9)	105⅞" (267.7)	Cord tilt Wand tilt Cordless wand tilt Cordless cord tilt	3⅞" (10.1) 3⅞" (10.1) 3⅞" (9.6) 3⅞" (9.6)	4⅞" (11.3) 4⅞" (11.3) 4⅞" (10.8) 4⅞" (10.8)
3½" (8.9 cm) Craftsman Valance  Valance Returns ½" (1.3 cm) to 1" (2.6 cm): glued 1⅛" (2.7 cm) to 4⅝" (11.8 cm): optional glued 4⅞" (12.0 cm) and greater: not glued	1" (2.6 cm) Wood	100¼" (254.7)	98⅞" (249.9)	Wand tilt	2⅞" (5.3)	2⅞" (6.1)
	2" (5.1 cm) Wood 2" (5.1 cm) Elite Wood	100¼" (254.7)	98⅞" (249.9)	Cord tilt Wand tilt Cordless wand tilt Cordless cord tilt	2⅞" (7.4) 3⅞" (9.1) 3⅞" (8.6) 2¾" (7.0)	3⅞" (8.3) 3⅞" (9.9) 3⅞" (9.6) 3⅞" (7.8)
	2⅝" (6.1 cm) Wood 2⅝" (6.1 cm) Elite Wood	100¼" (254.7)	98⅞" (249.9)	Cord tilt Wand tilt Cordless wand tilt Cordless cord tilt	3⅞" (9.6) 3⅞" (9.6) 3⅞" (9.1) 3⅞" (9.1)	4⅞" (10.4) 4⅞" (10.4) 3⅞" (10.1) 3⅞" (10.1)
	Wood Verticals	100¼" (254.7)	98⅞" (249.9)	N/A	5½" (14.0)	5⅞" (14.8)
3½" (8.9 cm) Legacy Valance  Valance Returns ½" (1.3 cm) to 1" (2.6 cm): glued 1⅛" (2.7 cm) to 4⅝" (11.8 cm): optional glued 4⅞" (12.0 cm) and greater: not glued	1" (2.6 cm) Wood	100¼" (254.7)	98⅞" (249.9)	Wand tilt	2⅞" (5.3)	2⅞" (6.2)
	2" (5.1 cm) Wood 2" (5.1 cm) Elite Wood	100¼" (254.7)	98⅞" (249.9)	Cord tilt Wand tilt Cordless wand tilt Cordless cord tilt	2⅞" (7.4) 3⅞" (9.1) 3⅞" (8.6) 2¾" (7.0)	3⅞" (8.5) 4 (10.2) 3⅞" (9.7) 3⅞" (8.0)
	2" (5.1 cm) Distressed Wood [^] 2" (5.1 cm) Elite Authentic Hardwood [^]	100¼" (254.7)	98⅞" (249.9)	Cord tilt Wand tilt Cordless wand tilt Cordless cord tilt	2⅞" (7.4) 3⅞" (9.1) 3⅞" (8.6) 2¾" (7.0)	3⅞" (8.5) 4 (10.2) 3⅞" (9.7) 3⅞" (8.0)
	2⅝" (6.1 cm) Wood 2⅝" (6.1 cm) Elite Wood	100¼" (254.7)	98⅞" (249.9)	Cord tilt Wand tilt Cordless wand tilt Cordless cord tilt	3⅞" (9.6) 3⅞" (9.6) 3⅞" (9.1) 3⅞" (9.1)	4⅞" (10.7) 4⅞" (10.7) 4⅞" (10.4) 4⅞" (10.4)
4½" (11.5 cm) Symphony Valance  Valance Returns ½" (1.3 cm) to 1" (2.6 cm): glued 1⅛" (2.7 cm) to 4⅝" (11.8 cm): optional glued 4⅞" (12.0 cm) and greater: not glued	1" (2.6 cm) Wood	100¼" (254.7)	98⅞" (249.9)	Wand tilt	2⅞" (5.3)	2⅞" (7.2)
	2" (5.1 cm) Wood 2" (5.1 cm) Elite Wood	100¼" (254.7)	98⅞" (249.9)	Cord tilt Wand tilt Cordless wand tilt Cordless cord tilt	2⅞" (7.4) 3⅞" (9.1) 3⅞" (8.6) 2¾" (7.0)	3⅞" (9.3) 4⅞" (11.0) 4⅞" (10.5) 3⅞" (8.9)
	2⅝" (6.1 cm) Wood 2⅝" (6.1 cm) Elite Wood	100¼" (254.7)	98⅞" (249.9)	Cord tilt Wand tilt Cordless wand tilt Cordless cord tilt	3⅞" (9.6) 3⅞" (9.6) 3⅞" (9.1) 3⅞" (9.1)	4⅞" (11.5) 4⅞" (11.5) 4⅞" (11.0) 4⅞" (11.0)
	Wood Verticals	100¼" (254.7)	98⅞" (249.9)	N/A	5½" (14.0)	6¼" (15.9)

*Continuous valances wider than sizes shown above will have two or more sections spliced together with a keystone.

Maximum width for spliced valances is 300⅞" (764.0 cm).

[^]Keystones not available.

Measuring and Ordering Worksheet

Window #1 _____
(location)

Measuring

For Inside Mount

Depth of window casing: _____

Special Return Length

(Standard Return Length XX - Depth XX = Special Return Length XX)

Standard Return Length: _____

Depth: _____

Special Return Length: _____

Measure width of window in 3 places and circle the narrowest width below:

Width #1: _____

Width #2: _____

Width #3: _____

Measure height of window in 3 places and circle the longest height below:

Height #1: _____

Height #2: _____

Height #3: _____

For Outside Mount

Width: _____

Height: _____

Ordering

Mount Type: Inside Outside

Ordering Width: _____

Ordering Height: _____

Type of Blind or Shade: _____

Style Name: _____

Color Number: _____

Controls & Options to consider:

Corded

Cordless

Bottom Up/Top Down
(Cellular, Pleated, Roman, and Natural Shades)

Sun Up/Sun Down
(Cellular & Pleated Shades only)

Cornice: _____

Valance: _____

Other: _____

Window #2 _____
(location)

Measuring

For Inside Mount

Depth of window casing: _____

Special Return Length

(Standard Return Length XX - Depth XX = Special Return Length XX)

Standard Return Length: _____

Depth: _____

Special Return Length: _____

Measure width of window in 3 places and circle the narrowest width below:

Width #1: _____

Width #2: _____

Width #3: _____

Measure height of window in 3 places and circle the longest height below:

Height #1: _____

Height #2: _____

Height #3: _____

For Outside Mount

Width: _____

Height: _____

Ordering

Mount Type: Inside Outside

Ordering Width: _____

Ordering Height: _____

Type of Blind or Shade: _____

Style Name: _____

Color Number: _____

Controls & Options to consider:

Corded

Cordless

Bottom Up/Top Down
(Cellular, Pleated, Roman, and Natural Shades)

Sun Up/Sun Down
(Cellular & Pleated Shades only)

Cornice: _____

Valance: _____

Other: _____

Window #3 _____
(location)

Measuring

For Inside Mount

Depth of window casing: _____

Special Return Length

(Standard Return Length XX - Depth XX = Special Return Length XX)

Standard Return Length: _____

Depth: _____

Special Return Length: _____

Measure width of window in 3 places and circle the narrowest width below:

Width #1: _____

Width #2: _____

Width #3: _____

Measure height of window in 3 places and circle the longest height below:

Height #1: _____

Height #2: _____

Height #3: _____

For Outside Mount

Width: _____

Height: _____

Ordering

Mount Type: Inside Outside

Ordering Width: _____

Ordering Height: _____

Type of Blind or Shade: _____

Style Name: _____

Color Number: _____

Controls & Options to consider:

Corded

Cordless

Bottom Up/Top Down
(Cellular, Pleated, Roman, and Natural Shades)

Sun Up/Sun Down
(Cellular & Pleated Shades only)

Cornice: _____

Valance: _____

Other: _____